



## Programmable Attenuator PAH-3G/122-TTL

MTS-No.: 29854

### Description

The PAH-3G/122-TTL from MTS Systemtechnik is designed for operations between 10 MHz and 3000 MHz. The attenuation of this unit is adjustable, continuously and without breaks from 0 to 122 dB in 0.5 dB steps. The interchangeable in- and output ports are protected by internal blocking capacitors.

This attenuator can be used very flexible because of its compact design and the controlling via TTL interface (8 bit parallel).



### Technical data:

#### 1 RF-specifications:

1.1 Impedance	50 Ω		
1.2 Input power (see plot)	≥ 50 MHz		
- Absolute <sup>1</sup>	31 dBm max.		
- Operating: Pulsed <sup>2</sup>	28 dBm max.		
- Operating: CW	23 dBm max.		
1.3 Voltage rating	50 WVDC		
1.4 Frequency range	10 - 3000 MHz (1 MHz on request)		
1.5 Attenuation	0 - 122 dB in 0.5 dB steps (glitch-less state transitions)		
	<b>min.</b>	<b>typ.</b>	<b>max.</b>
1.6 VSWR in / out			
@ 10 - 700 MHz			
@ 0 - 5.0 dB		1.5	2.1
@ 5.5 - 122.0 dB		1.2	1.8
@ 700 - 3000 MHz		1.2	1.8
1.7 Insertion loss (IL)			
@ 10 MHz		3.4 dB	3.7 dB
@ 3000 MHz		7.4 dB	8.0 dB
1.8 IL derating / 20 MHz		0.03 dB	
1.9 Relative phase		60°	
@ 0 - 122 dB			
1.10 Input IP3	50 dBm		
1.11 Switching speed		0.3 μs	
1.12 Attenuation accuracy	(negative means more attenuation)		
@ 10 - 3000 MHz			
@ 0.5 - 30.0 dB		+0.0/-0.5 dB	+0.5/-1.0 dB
@ 30.5 - 60.0 dB		+0.0/-0.5 dB	+0.5/-1.5 dB
@ 60.5 - 95.0 dB		+0.0/-1.0 dB	+1.0/-3.0 dB
@ 95.5 - 122.0 dB		+0.0/-2.0 dB	+6.0/-8.0 dB

#### 2 Connections:

2.1 RF connectors	SMA female
2.2 Control connector	12pole male, type SMC Erni

#### 3 General specifications:

3.1 Internal voltage (TTL)	5 VDC ±5 %
3.2 Power consumption	5 mW max.
3.3 Control	8 bit parallel (TTL)
3.4 Operating temperature	-40 °C - +85 °C
3.5 Storage temperature	-55 °C - +150 °C
3.6 Reference temperature of specifications (typ.)	+25 °C
3.7 Dimensions (without connections) (LxWxH)	65.4 mm x 48.7 mm x 11.0 mm
3.8 Case style	Milled aluminium enclosure
3.9 Colour	SurTec650 (Chrome alloy)
3.10 Weight	80 grams

#### 4 Delivered parts:

PAH-3G/122-TTL  
 Datasheet  
 Drawing and connector pin assignment

#### 5 Comments:

Warranty 12 months  
 RoHS-compliant Yes

#### 6 Recommended accessories:

RF-cables  
 Processor card

Notes: 1. Exceeding absolute maximum ratings may cause permanent damage.

2. Pulsed, 5 % duty cycle of 4620 μs, 50 Ω. Operation between operating maximum and absolute maximum may reduce reliability.

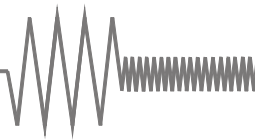

# Programmable Attenuator PAH-3G/122-TTL

MTS-No.: 29854

Typical measurements:

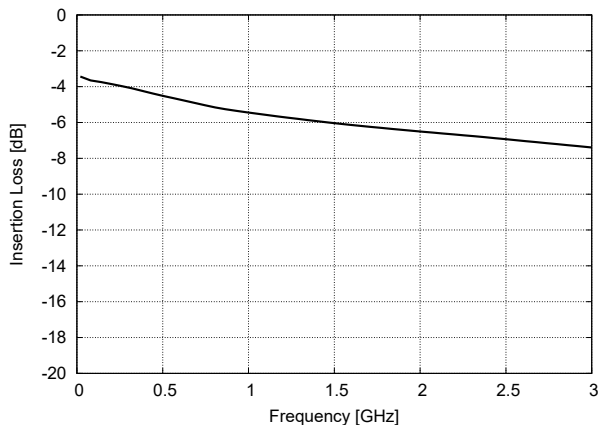

Fig. 1: Input port to output port insertion loss

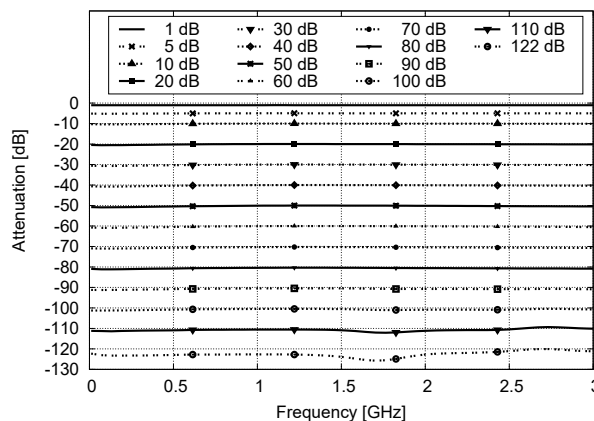

Fig. 2: Attenuation relative to insertion loss

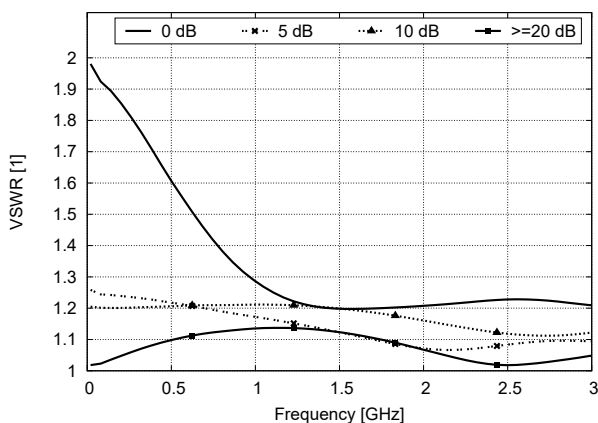

Fig. 3: VSWR for input and output ports

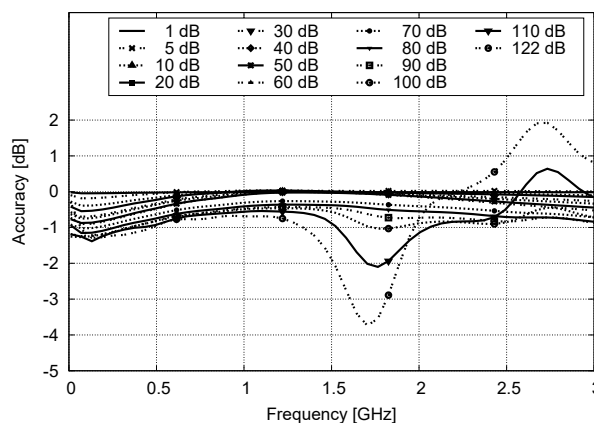

Fig. 4: Attenuation accuracy

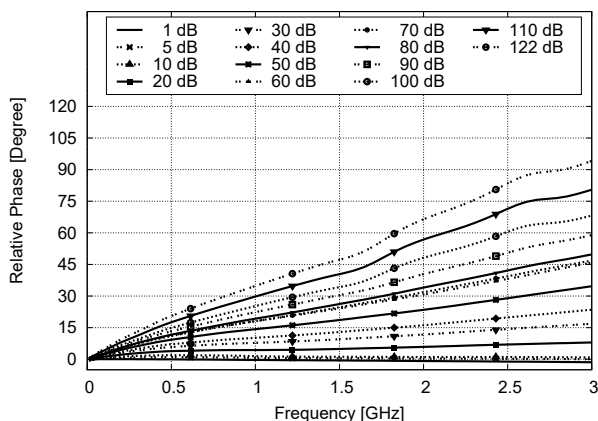

Fig. 5: Phase relative to insertion loss

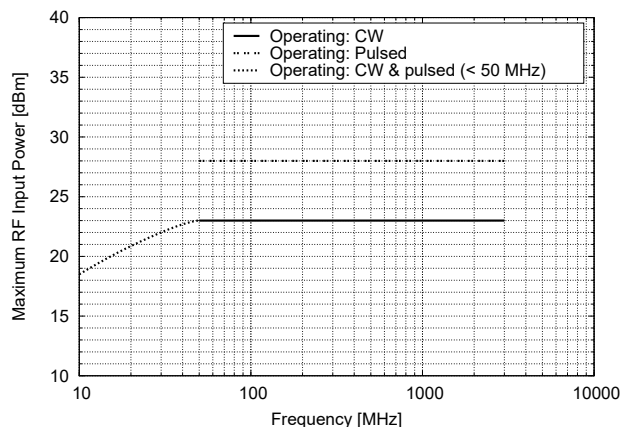
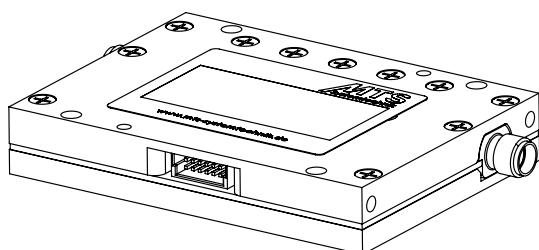
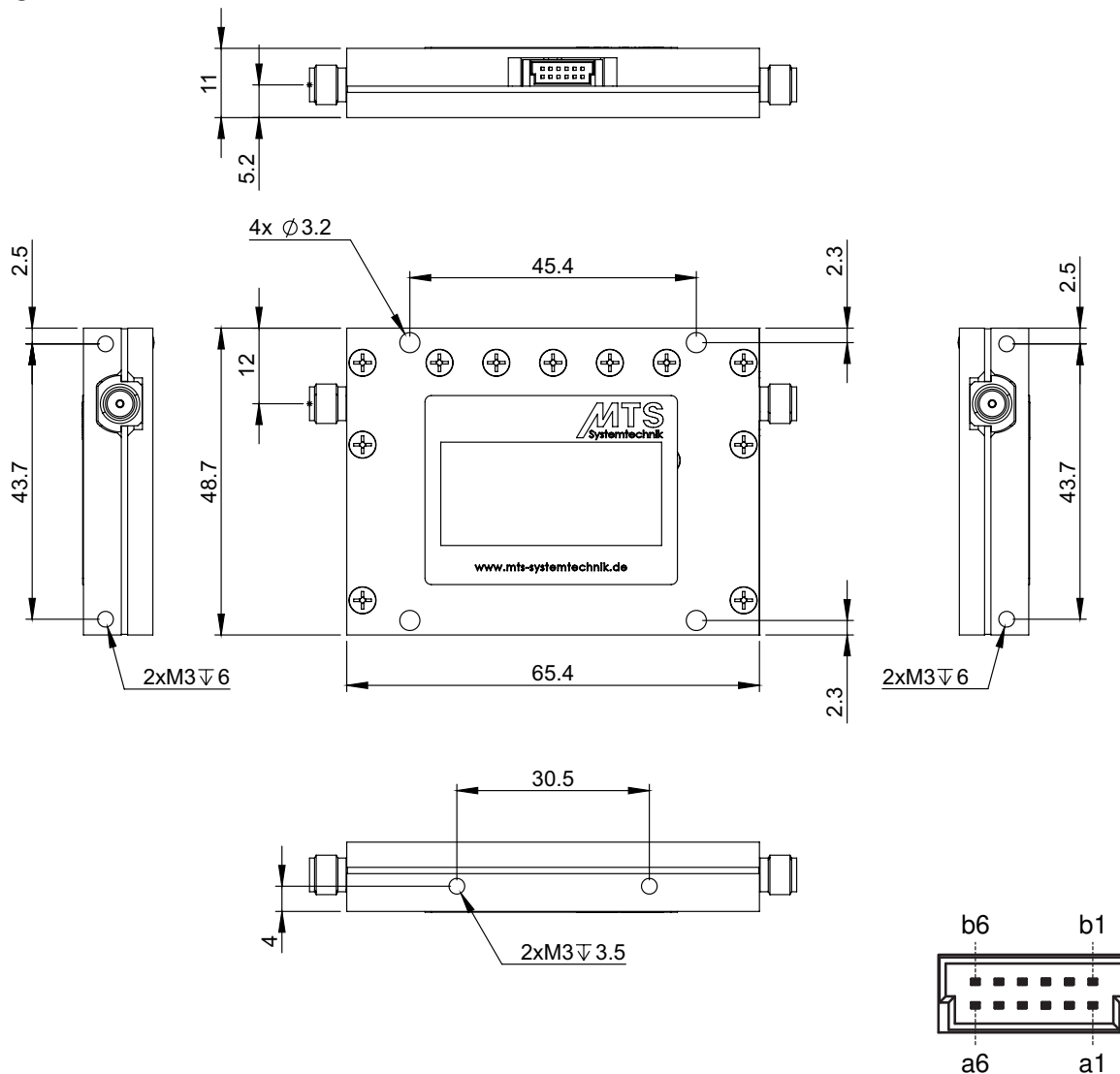

Fig. 6: Power derating curve

# Programmable Attenuator PAH-3G/122-TTL

MTS-No.: 29854

Views:



Pin assignment			
Pin	Grade	Pin	Grade
a1	D0 (0.5 dB)	b1	D1 (1 dB)
a2	D2 (2 dB)	b2	D3 (4 dB)
a3	D4 (8 dB)	b3	D5 (16 dB)
a4	D6 (32 dB)	b4	D7 (58.5 dB)
a5	+5V	b5	+5V
a6	GND	b6	GND