



Programmable Attenuator PAH-8G/95-TTL

MTS-No.: 29250

Description

The PAH-8G/95-TTL from MTS Systemtechnik is designed for operations between 10 MHz and 8000 MHz. The attenuation of this unit is adjustable, continuously and without breaks from 0 to 95 dB in 0.5 dB steps. The interchangeable in- and output ports are protected by internal blocking capacitors.

This attenuator can be used very flexible because of its compact design and the controlling via TTL interface (8 bit parallel).



Technical data:

1 RF-specifications:

1.1 Impedance	50 Ω		
1.2 Input power			
- Absolute ¹	34 dBm max.		
- Operating: Pulsed ²	31 dBm max.		
- Operating: CW	28 dBm max.		
1.3 Voltage rating	50 WVDC		
1.4 Frequency range	10 - 8000 MHz (1 MHz on request)		
1.5 Attenuation	0 - 95 dB in 0.5 dB steps (glitch-safe state transitions)		
	min.	typ.	max.
1.6 VSWR in / out			
@ 10 - 700 MHz			
@ 0 - 5 dB	1.6	2.1	
@ 5.5 - 95 dB	1.3	1.8	
@ 700 - 8000 MHz	1.3	1.8	
1.7 Insertion loss (IL)			
@ 10 MHz	3.4 dB	3.7 dB	
@ 4000 MHz	5.5 dB	6.1 dB	
@ 8000 MHz	6.7 dB	7.6 dB	
1.8 IL derating / 20 MHz	0.01 dB		
1.9 Relative phase		25°	
@ 0 - 95 dB			
1.10 Input IP3	50 dBm		
1.11 Switching speed	0.5 μs		
1.12 Attenuation accuracy	(negative means more attenuation)		
@ 2000 - 6000 MHz			
@ 0.5 - 30.0 dB	±0.4 dB	+0.5/-1.0 dB	
@ 30.5 - 60.0 dB	-0.5/-1.0 dB	+0.0/-1.5 dB	
@ 60.5 - 85.0 dB	-0.5/-1.5 dB	+0.0/-2.0 dB	
@ 85.5 - 95.0 dB	-0.5/-1.5 dB	+0.5/-3.0 dB	
@ 10 - 8000 MHz			
@ 0.5 - 30.0 dB	+0.0/-1.0 dB	+0.5/-1.5 dB	
@ 30.5 - 60.0 dB	-0.5/-1.5 dB	+0.0/-2.5 dB	
@ 60.5 - 85.0 dB	-0.5/-2.0 dB	+0.0/-3.0 dB	
@ 85.5 - 95.0 dB	-0.5/-3.5 dB	+0.5/-6.0 dB	

2 Connections:

2.1 RF connectors	SMA female
2.2 Control connector	12pole male, type SMC Erni

3 General specifications:

3.1 Internal voltage (TTL)	5 VDC ±5 %
3.2 Power consumption	5 mW max.
3.3 Control	8 bit parallel (TTL)
3.4 Operating temperature	-40 °C - +85 °C
3.5 Storage temperature	-55 °C - +150 °C
3.6 Reference temperature of specifications (typ.)	+25 °C
3.7 Dimensions (without connections) (LxWxH)	56.4 mm x 48.7 mm x 11.0 mm
3.8 Case style	Milled aluminium enclosure
3.9 Colour	SurTec650 (Chrome alloy)
3.10 Weight	70 grams

4 Delivered parts:

PAH-8G/95-TTL
 Datasheet
 Drawing and connector pin assignment

5 Comments:

Warranty 12 months
 RoHS-compliant Yes

6 Recommended accessories:

RF-cables
 Processor card

Notes: 1. Exceeding absolute maximum ratings may cause permanent damage.

2. Pulsed, ≤ 5 % duty cycle, 50 Ω. Operation between operating maximum and absolute maximum may reduce reliability.

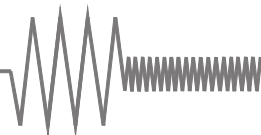

Programmable Attenuator PAH-8G/95-TTL

MTS-No.: 29250

Typical measurements:

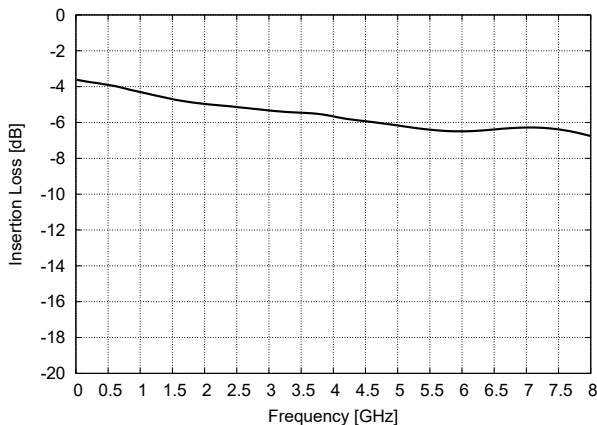

Fig. 1: Input port to output port insertion loss

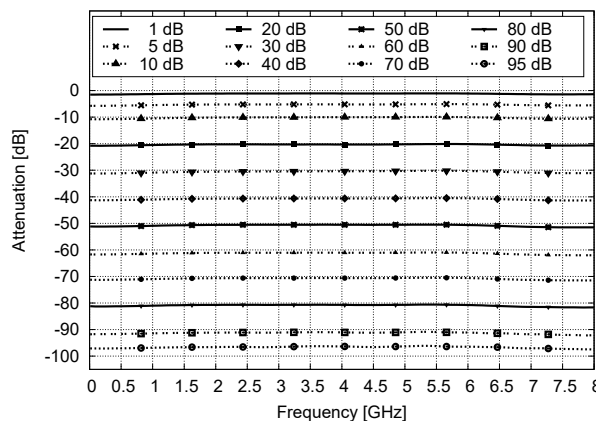

Fig. 2: Attenuation relative to insertion loss

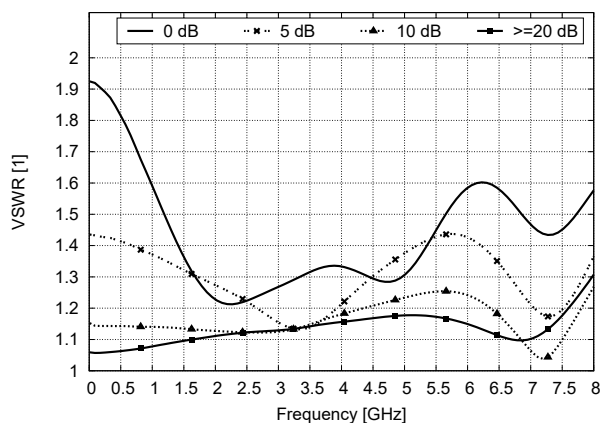

Fig. 3: VSWR for input and output ports

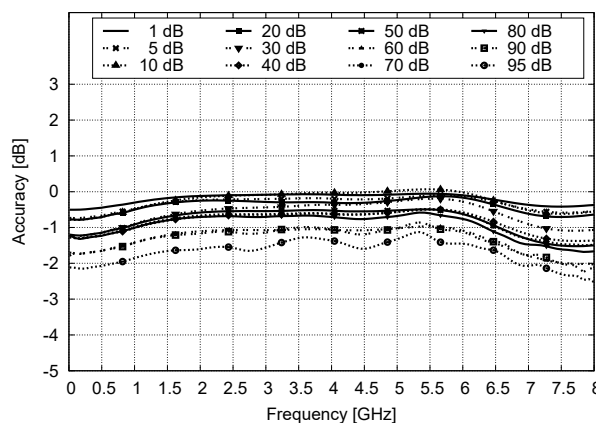

Fig. 4: Attenuation accuracy

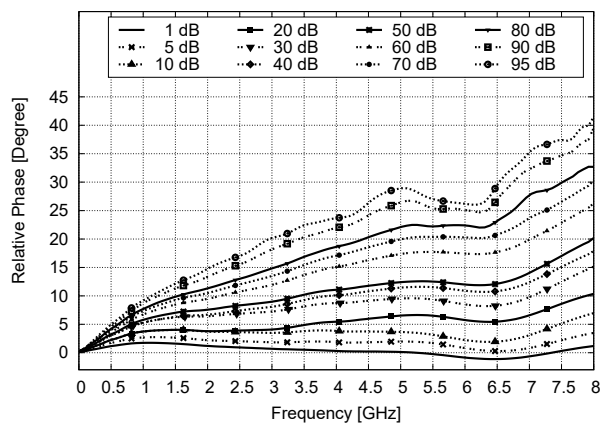
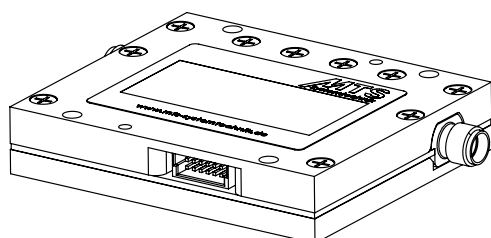
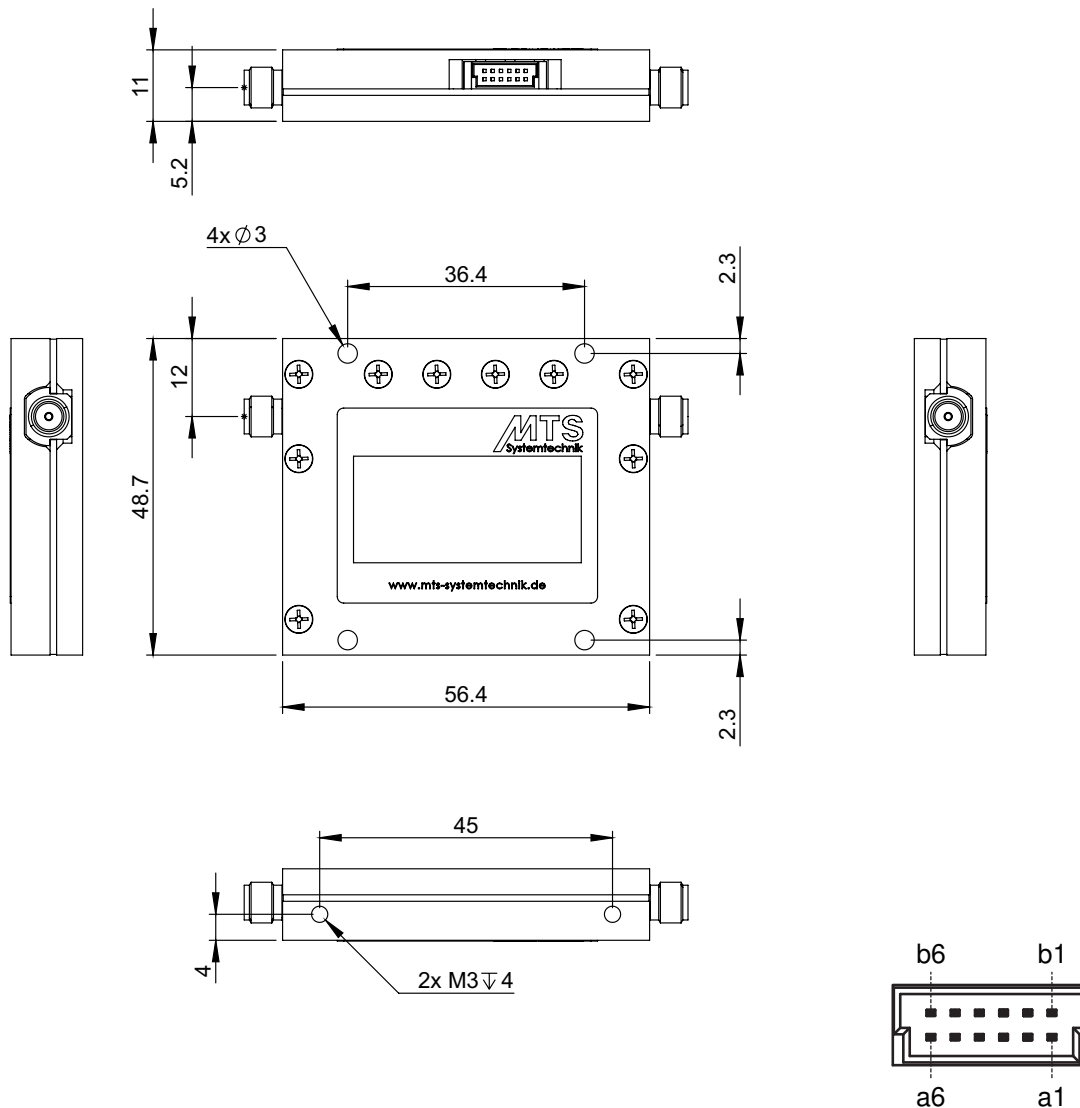

Fig. 5: Phase relative to insertion loss

Programmable Attenuator PAH-8G/95-TTL

MTS-No.: 29250

Views:



Pin assignment			
Pin	Grade	Pin	Grade
a1	D0 (0.5 dB)	b1	D1 (1 dB)
a2	D2 (2 dB)	b2	D3 (4 dB)
a3	D4 (8 dB)	b3	D5 (16 dB)
a4	D6 (32 dB)	b4	D7 (31.5 dB)
a5	+5V	b5	+5V
a6	GND	b6	GND